

Data Sheet



Article number: 339702510000

Description: Multibeam 6 Coupling 702.51.0000
St. steel & set screw hubs

Measures

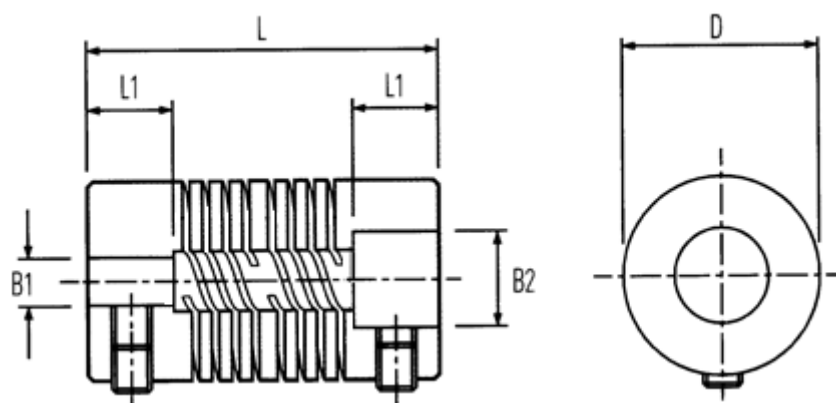

B1: Pre-drilled	= 10.0
B2: Pre-drilled	= 16.00
D	= 50.8
L	= 95.3
L1	= 25.0
Max angular displacement	= 0.90
Max B1 & B2	= 28.00
Max parallel displacement	= 7

Peak Torque NM	= 73.00
Set Screw	= M8